



ergolet[®]

Luna/200

Luna/275

Ceiling hoist

User instruction



Important - warning

This manual must be read before the Luna is used

This manual is intended for technicians, installers, therapists and other personnel, in connection with the use, servicing and maintenance of the Ergolet Luna ceiling hoist.

Date: 1.10.2012 - Version 18

Contents

1. Aim and use

| | | |
|-----|---|---|
| 1.1 | Purpose | 4 |
| 1.2 | Safety instructions | 4 |
| 1.3 | Daily check | 5 |
| 1.4 | Terminology | 5 |
| 1.5 | Unpacking | 6 |
| 1.6 | Mounting and dismantling the lifting unit | 6 |
| 1.7 | Fitting the spreader bar | 8 |
| 1.8 | Lifting slings | 9 |

2. Functions

| | | |
|-----|--|----|
| 2.1 | Pictograms and functions - lift cassette | 10 |
| 2.2 | Pictograms and functions - hand control | 11 |
| 2.3 | Operation and technical | 12 |
| 2.4 | Safety functions | 12 |
| 2.5 | Charging | 13 |
| 2.6 | Transport | 13 |

3. Using Luna

| | | |
|-----|------------------------------------|----|
| 3.1 | Using Luna | 14 |
| 3.2 | Room to room transfer | 14 |
| 3.3 | Adjusting the length of the strap | 16 |
| 3.4 | Using Luna in a shower environment | 16 |

4. Maintenance

| | | |
|-----|----------|----|
| 4.1 | Cleaning | 17 |
| 4.2 | Storage | 17 |

5. Check and trouble-shooting

| | | |
|-----|------------------|----|
| 5.1 | Annual check | 17 |
| 5.2 | Trouble-shooting | 18 |

6. Technical data and sketches

| | | |
|-----|---------------------------------|----|
| 6.1 | Luna – technical specifications | 20 |
|-----|---------------------------------|----|

7. Environment and quality

| | | |
|-----|-------------------------------|----|
| 7.1 | Batteries and the environment | 21 |
|-----|-------------------------------|----|

8. Accessories and spare parts

22

1.1 Purpose

Luna is a ceiling hoist designed to transfer clients in institutions such as nursing homes, hospitals, care centres and in home care. The Luna ceiling hoist can be used as a ceiling mounted lift or as a mobile lift in fixed or movable track systems. Can be used for transfer between bed and chair and from chair to toilet etc.

Before using the Luna please make sure you carefully read and adhere to the following instructions:

- Personnel have received qualified instruction by Ergolet in using the Luna track lift.
- Luna is used in suitable track systems that have been approved by Ergolet.
- System assembly is carried out by installers authorised by Ergolet.
- Luna can only be fitted with spreader bars supplied by Ergolet.
- The Luna system has been developed for use with Ergolet lifting slings and other sling products authorised by Ergolet. See Ergolet's sling leaflet for specific information about authorised models.

1.2 Safety instructions

Note: Important information!

This user guide must be read thoroughly before Luna is taken into service.

- All parts must be mounted correctly according to this guide.
- There must be no indication of wear on the Luna track lift, track system or lifting sling.
- NEVER begin lifting if there is suspicion of any defect (abnormal sound, loose brackets etc.) In such cases the lift must be taken out of service immediately and your dealer or Ergolet contacted.
- The Luna lifting capacity is 200 kg or 275 kg and must never be exceeded. When using Luna in connection with other components e.g. slings or transportable track systems it is always the component with the LOWEST weight capacity that decides the maximum lifting capacity.
- Ensure that neither carers/helpers nor clients/users can be hurt during the lifting.
- Never lift higher than necessary in the actual lifting situation.
- See section 5.1 (annual check) for further information.
- When using the Luna hand control over or near a bathtub or shower unit ensure that no immersion in water can occur (see section 3.4)
- Luna should never be used in an environment containing chlorine or in other aggressive environments.

1.3 Daily check

The carer/helper is responsible in ensuring that a daily check is carried out BEFORE Luna and accessories are used, including the following:

- 1) Lifting slings are checked for wear and tear or any damage especially as regards lifting straps. The slings must not be used if defects are detected.
- 2) The lifting strap on the Luna is checked for wear and tear or damage. If there is any sign of a defect, the Luna must be taken out of use.
- 3) If any abnormal sound is heard from the Luna the lift must not be used before personnel authorised by Ergolet have carried out a safety check on the unit.
- 4) Check that the lifting strap moves into the lifting unit without touching the edges of the hole.
- 5) If in any doubt concerning the use of Luna or lifting slings contact Ergolet for advice and guidance.

Luna mounted on the strap

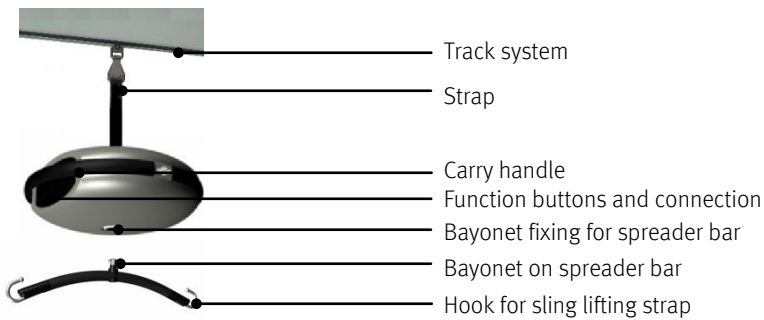

Fig. 1.4A

Luna mounted on the track

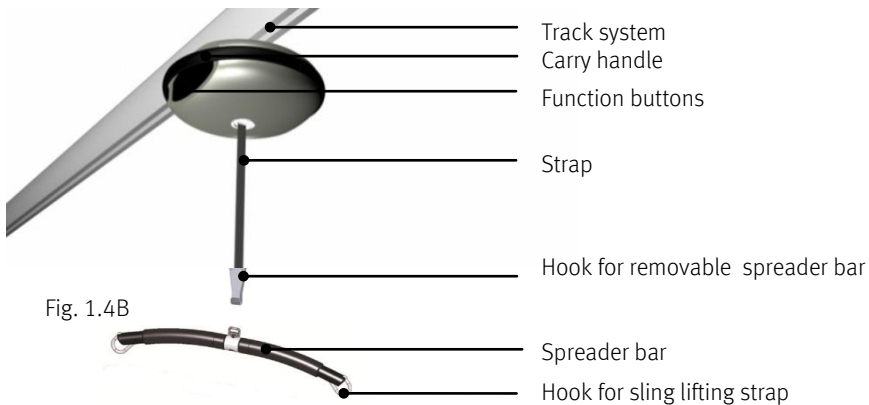

Fig. 1.4B

1.5 Unpacking

Check that all the parts are present and undamaged. Any suspicion of damage or shortage should be reported to your dealer or Ergolet. We recommend that the box packaging is kept if Luna is to be used on other sites or for return shipment in case of repair or annual check.

Contents of the box

1. Luna lifting unit
2. Hand control
3. Charger and holder
4. Spreader bar
5. User guide

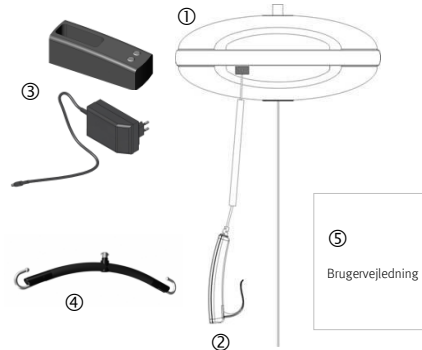

Fig. 1.5A

1.6 Mounting and dismantling the lifting unit

Luna can be mounted in different modes to satisfy varying needs. The mode of mounting is decided between the buyer and Ergolet representative. The Luna lift cassette has been readied for mounting in one of the following modes:

A) Mounted on the track

Luna is mounted directly on the track, where a cart is also positioned to receive the unit. This cart has a bayonet bracket to connect with the corresponding receptacle on the Luna (Fig. 1.6A).

(1) Lift the Luna cassette up to the cart and connect the bayonet bracket into the Luna (resistance will be felt since the bracket is spring loaded).

(2) Luna is now turned 90 degrees clockwise. When Luna is in place a click can be heard. This indicates correct mounting.

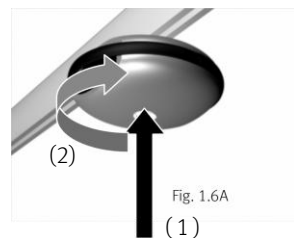

Note: If Luna is not mounted correctly an electronic safety device prevents operation of the unit.

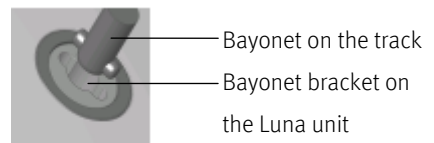

Dismounting

Press Luna upwards against the cart (the unit is spring loaded), turn 90 degrees anti-clockwise to dismount the Luna.

Note: Please remember that Luna weighs 6,7kg when carrying out this procedure.

B) Mounted on the strap

Luna is mounted by connecting the hooked strap to the cart in the track. The strap and hook for mounting is already attached to the Luna unit. (Fig. 1.6B)

The spring loaded hook is connected to the cart in the track. Position the hook in the cart and pull downwards to fix. Ensure that the hook is safely locked. (see fig. 1.7C)



Fig. 1.6B

Dismounting Luna using Luna Trolley:

After lowering the Luna on to the cradle on the trolley and leaving the strap slightly slackened, press the spring loaded part of the hook inwards using the extension arm (see fig. 1.6C).

Leave the hook on the extension arm and the hook will be ready for the next mounting.

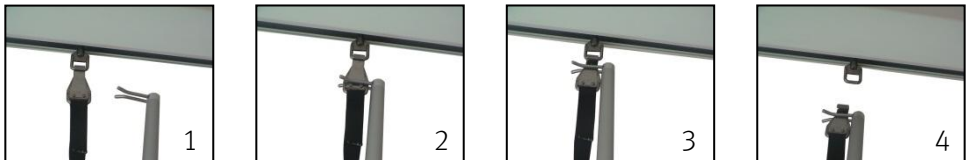

Fig. 1.6C

Extension arm or Luna Trolley with extension arm can be purchased from Ergolet or your local dealer.

1.7 Fitting the spreader bar

A) Mounting directly onto the lift cassette

The spreader bar is mounted relevant to the chosen lift fixing position. The spreader bar is fitted with a bayonet bracket which can be fitted directly onto the Luna cassette. Note that the spreader bar is always fitted directly opposite the strap exit on the Luna. (Fig. 1.7A)

(1) Lift the spreader bar up to Luna, push the bayonet bracket up into Luna's corresponding hole (opposite the strap exit). Resistance will be felt due to a spring load.

(2) Turn the spreader bar 90 degrees clockwise. When the spreader bar is in place a click will be heard indicating correct fixing.

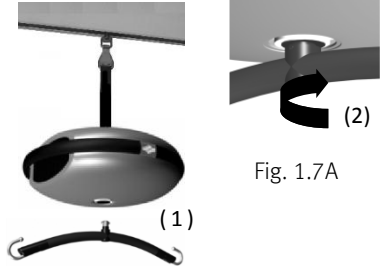

Fig. 1.7A

PS: If the spreader bar is not mounted correctly an electronic safety device prevents operation of the unit.

B) Mounting the spreader bar onto the strap

The spreader bar has a fixing ring; The Luna strap has a spring loaded hook (Fig. 1.7B).

See an overview of the different spreader bars in chapter 8.

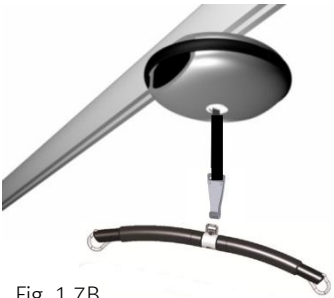

Fig. 1.7B

The spreader bar is lifted up to the strap and the spring loaded hook of the strap drawn sideways onto the ring. Pull downwards until the hook is fixed on the spreader bar ring. Ensure that the hook is safely locked. (See fig. 1.7C)

Press the spring loaded part of the hook in, turn the

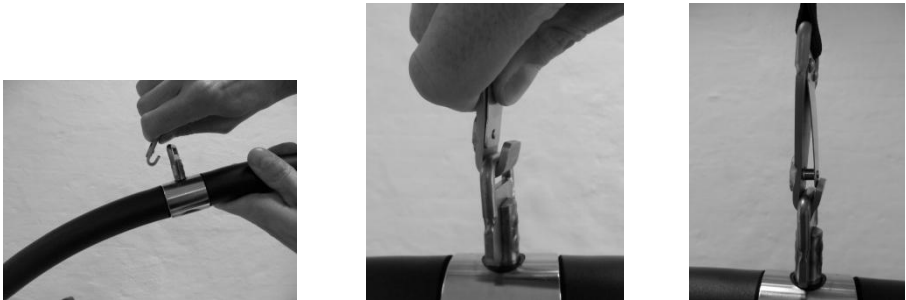

Fig. 1.7C

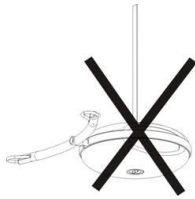

Fig. 1.7D

Warning

- 1) The spreader must always be mounted opposite the strap.
- 2) Only one spreader bar must be mounted on the lift cassette.
- 3) Ergolet takes no responsibility for faults or accidents that arise due to the use of spreader bar from other manufacturers. If in doubt contact your dealer or Ergolet.

1.8 Lifting slings

Luna spreader bars are designed for use with Ergolet lifting slings. Ergolet lifting slings have 2-6 lifting straps and are designed for lifting hooks larger than $\varnothing 8\text{mm}$. Use of non-authorized slings will render Ergolet's responsibility for faults and accidents null and void.

Ergolet can assist in choosing slings and also offer training sessions in transfer techniques and the correct use of slings.

Hanging slings on the Ergolet spreader bar

Ergolet accepts no responsibility if slings are placed incorrectly, it is always the onus of the carer/helper to ensure that the sling is correct for the situation needs and is correctly mounted.

(1) The sling strap is placed over the hook in its open position. (Fig. 1.8A)

(2) The strap is pulled downwards so that the hook closes. (Fig. 1.8B)

The design of the lifting hook is such that the weight of the client/user will help close the hook.

To release the strap after lifting simply pull upwards to open the hook.

Note: Risk of finger entrapment - ensure that client's fingers cannot get trapped.

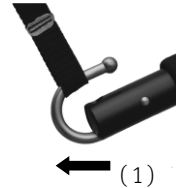

Fig. 1.8A

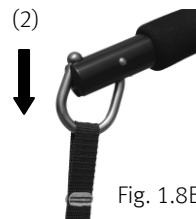

Fig. 1.8B

2.1 Pictograms and functions – Side foil

Side foil pictograms

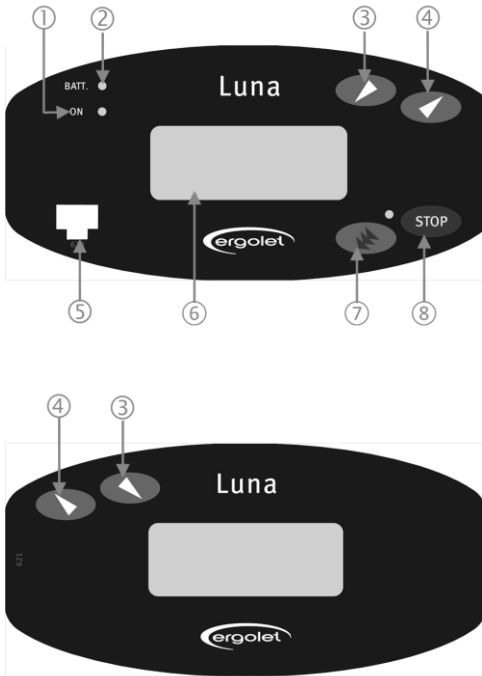

Fig 2.1

(1) ON – If LED is off Luna is in “sleep” mode. The LED light will turn on when the button up **(4)** or down **(3)** on the hand control is pressed.

(2) BATT. – Indicates the level of the battery (see section 2.5).

(4)+(3) UP/DOWN – on both side foils, constant hold will move the lift in the desired direction. Release the button to stop movement.

Note: Works only with hand control plugged in and LED **(1)** must be on.

(5) PLUG INSERTION – to insert the hand control plug.

(6) SUPPLIER AND SERVICE DATA

(7) EMERGENCY LOWERING – Used in situations where it is necessary to lower a client safely in a lift failure. This button must be held constantly to lower the unit. A “beep” sound will be heard during this operation, the movement will start after approx. 5 sec.

Note: Works only with hand control plugged in and LED **(1)** must be on.

(8) EMERGENCY STOP – Push to stop Luna immediately. This function is reset by holding reset button on hand control for 5 sec. (see section 2.2).

2.2 Pictograms and functions – Hand control

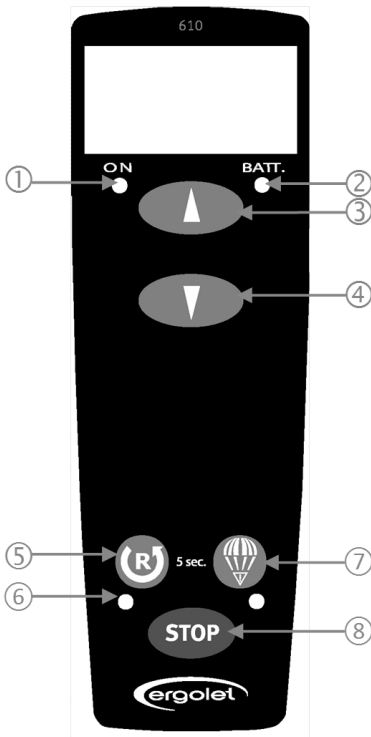

(1)ON – The LED light will turn on when the button up **(3)** or down **(4)** is used.

(2)BATT. – indicates the state of the battery (see section 2.5)

(3)+ (4)UP/DOWN – constant hold will move the lifter in the desired direction – release to stop.

(5) RESET – Used to reactivate the lifter after the use of the stop- or lock function. Reset by holding the same button for 5 seconds. Can also be used to lock all functions to avoid unintended use by e.g. the client. After holding the button for 5 sec, the LED (6) will turn on and the function is activated.

(7) EMERGENCY LOWERING – Used in situations where it is necessary to lower a client safely in a lift failure. This button must be held constantly to lower the unit. A “beep” sound will be heard during this operation, the movement will start after approx. 5 sec.

Note: Hold up or down button if Luna is in sleep mode

(8) STOP – this button stops all functions immediately (this can be reset by holding the reset/lock button for 5 seconds).

2.3 Operation and technical

Connect the hand control to the plug inlet on the front panel, see fig. 2.1 (pos 5).

Luna is now ready for use.

Note: Luna will not operate before spreader bar, hand control and Luna is mounted correctly.

Luna will move faster when not loaded in order to reach the client without too much waiting time. When the client is lifted the speed will automatically reduce to increase comfort and safety for the client.

Luna is intended for indoor use under normal temperatures (+2 to +40 degrees Celsius) and relative humidity (40 –90%). The unit should be protected against sudden changes in temperature/humidity since these can damage the lift functions.

When using the Luna hand control over or near a bathtub or shower unit ensure that no immersion in water can occur. (See section 3.4)

2.4 Safety functions

Emergency stop:

This function is only to be used in an emergency eg. if the Luna does not react or does not stop after releasing the hand control operation. This button stops all functions immediately.

If this function has been activated due to an emergency Luna must not be used again before a check has been made and any defect repaired. Emergency stop can be deactivated by depressing the Reset/lock button for 5 seconds.

Emergency lowering button:

This is also only to be used in an emergency where it is necessary to safely lower a client.

If this function has been activated due to an emergency Luna must not be used again before a check has been made and any defect repaired. Pressing this button gives several “beep” sounds, hold the button for 5 seconds before the movements starts. This is a hold to run button.

Note: When using emergency lowering, end stop is not active. Release the emergency lowering button when the strap is in its full length.

2.5 Charging..

Luna can be charged either from the charge holder mounted on the wall or through the charge unit on the Luna Trolley.

Move Luna to the charging station, place the hand control onto the charger after which charging starts automatically.

When Luna is under charge the following takes place:

Green →  The green diode on the hand control will flash during charging.

When this diode shine constantly the batteries are fully charged.

Luna is fitted with batteries that require regular charging. Ergolet recommends that Luna is charged every night or when the unit is not in use.

Luna is fitted with a diode (marked BATT.) which gives the following information concerning battery condition during use:

Green →  When the batteries are fully charged the diode shines green.

Yellow →  When the batteries are approx. 50% the diode shines yellow – at this point it is recommended that Luna is put on charge.

Red →  If the batteries reach a critical point the diode will first shine red, then flash red and at the same time an acoustic ("beep, beep, beep" signal) will be heard. Luna must IMMEDIATELY be put on charge in this situation and remain on charge for 24 hours.

Luna cannot be overcharged.

2.6 Transport

Ergolet Luna track lift is most safely transported using the original packaging.

Symbols are printed on the packaging to ensure the best information to carrier companies.

3.1 Using Luna

Luna is ready for use if all the assembly instructions have been followed. The hand control is fitted to Luna via the plug (page 10 fig. 2.1A) and is used to activate the unit.

3.2 Room to room transfer

Transfer with two Luna ceiling hoist

Note: only possible with Luna for 200 kg

- 1) Luna (a) with client is moved to the door after which the lifting strap from Luna (b) is extended and fitted on the extra bracket on the spreader bar.
- 2) The lifting strap is fitted with a bracket that fits onto the spreader bar. The strap is brought sideways onto the spreader bar and pulled downwards to fix. (See fig 1.7C)
- 3) The lifting strap on Luna (a) released whilst the lifting strap on Luna (b) is tightened.
- 4) When the lifting strap on Luna (b) is vertical and tight this means that the client's weight is on this unit. The lifting strap on Luna can now be released.
- 5) The lifting strap on Luna (a) can now be removed by releasing the spring loaded hook on the spreader bar (this is done best by lifting the hook up, press the spring and remove). The transfer can now continue with Luna (b).

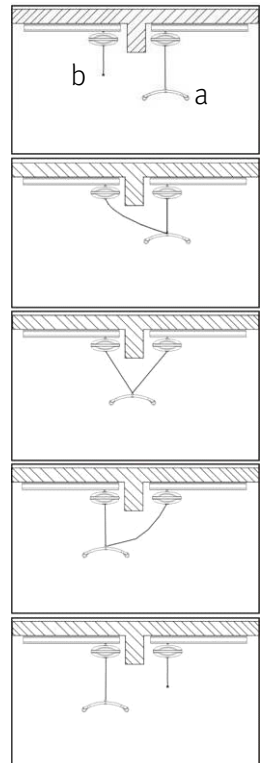

Fig. 3.2

Transfer with one Luna ceiling hoist

Note: only possible with Luna for 200 kg

The Luna unit and the cart in the other room are moved as close to each other as possible.

1) Luna (a) with client is moved to the door and the transfer strap (c) from the other room is fitted to the vacant ring bracket on Luna (a). The strap (c) is fitted with a spring loaded hook bracket that is brought up and sideways to the ring bracket on the Luna cassette, fixed in place to ensure safety.

2) The strap on Luna (a) is slowly released until the transfer straps (c) bears the clients weight.

3) The strap on Luna (a) can now be removed and fitted on the cart next to the transfer strap. (The lifting strap is best removed by bringing the bracket up, press the spring and remove). Hang the end of this strap in the bracket so that it is out of the way

The transfer can now continue in the new room.

Note: It may be necessary to adjust the length of the strap (see fig. 3.2C).

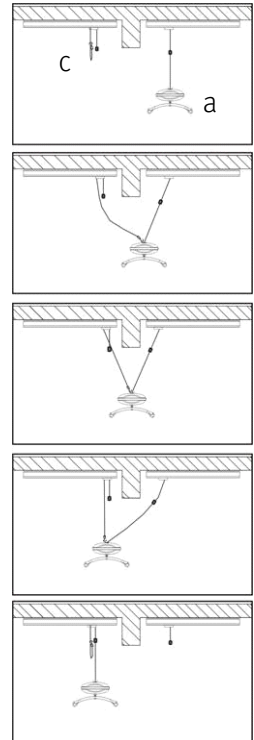

Fig. 3.2B

3.3 Adjusting the length of the strap

The length of the strap can be adjusted to fit the distance between the tracks in the 2 two rooms when doing a transfer between 2 rooms (see section 3.2).

- 1) The screw (d) is released.
- 2) The strap is placed in the correct position and the bolt (e) is placed in the corresponding loop (f) (see fig. 3.2C).
- 3) Ensure that the screw (d) and the bolt (e) is tightened before the Luna is mounted on the cart. Contact Ergolet for further information.

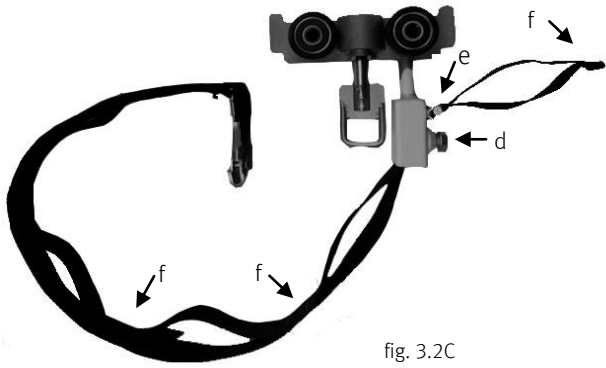

fig. 3.2C

3.4 Using Luna in a shower or bathing environment

It is important to ensure that the Luna lifting unit does not get in contact with water when using it in a shower or bathing environment. It is important to ensure that the hand control unit is not immersed in water. (See fig. 3.4).

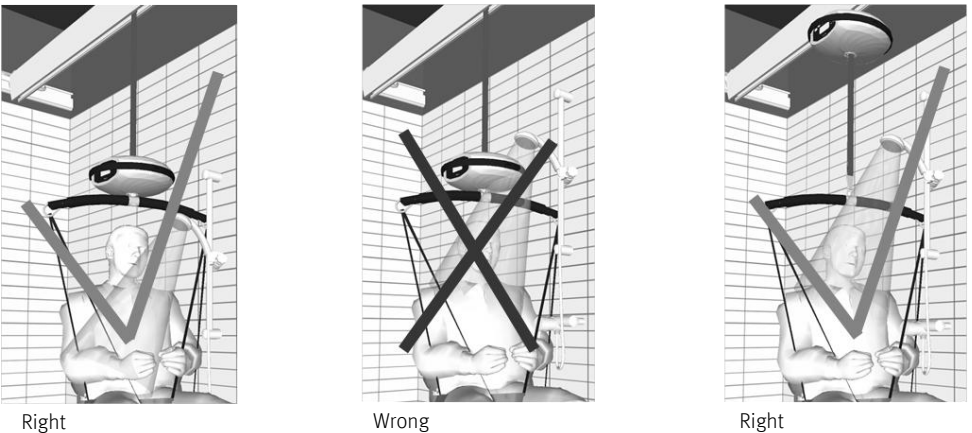

Fig 3.4

Note: Using a Luna in fixed mode, i.e. mounted on the track is the recommended solution for wet environments, as it makes it easier to avoid contact with water.

4.1 Cleaning

Luna may be cleaned using a slightly damp cloth with a small quantity standard household cleaning agent. Chemicals and other strong/abrasive agents must not be used.

Luna cannot under any circumstance be autoclaved.

4.2 Storage

Luna must be stored in a dry environment with relative humidity under 70%.

If the Luna is not to be used over a longer period of time it is best to fully charge the unit and activate the emergency button to save battery before putting in storage.

5.1 Annual check

Luna must always be maintained by qualified and authorised personnel who have been approved by Ergolet for replacing batteries, lifting straps and other components

The manufacturer Ergolet stipulates that this track lift **MUST** be checked by a qualified and authorised person at least once a year. This annual check is also recommended in the relevant European Standard (EN ISO 10535) for patient lifters/hoists including track lifters.

Ergolet's service personnel will fill out the logbook after each annual check. If it is necessary to replace any parts due to wear or damage these must be obtained/purchased from Ergolet.

5.2 Trouble-shooting

Fault:

Luna does not react when the hand control buttons UP/DOWN are used (No "beep" sound from the lift).

Possible cause:

Luna is not on or emergency stop is activated

Solution:

Deactivate emergency stop (see section 2.4)

Possible cause:

Defect hand control

Faultfinding:

Check if the lift reacts using the cassette panel buttons.

Solution:

Try using another hand control. Alternative is to get a new hand control from the dealer

Possible cause:

Flat batteries.

Solution:

Charge batteries (see section 2.5)

Fault:

Luna does not react when UP/DOWN buttons on the hand control are used ("Beep" sounds are heard)

Possible cause:

Spreader bar not mounted

Solution:

Mount spreader bar

Possible cause:

Luna is not mounted correct on the track cart

Solution:

Mount Luna correctly

Possible cause:

Batteries are almost flat

Solution:

Charge batteries (see section 2.5)

Possible cause:

The strap is rolled incorrectly

Solution:

Request service technician from dealer

Fault:

The lift does not react when the hand control UP button is used ("Beep" sounds are heard)

Possible cause:

The lifting capacity has been exceeded - Client too heavy or the sling has been caught in furniture etc.

Possible cause:

Flat batteries.

Solution:

Charge batteries (see section 2.5)

| | |
|--|--|
| Fault: Does not lift high enough | Possible cause: Lifting strap cannot come higher up due to the track position The straps on the chosen sling are too long. Solution: Contact Ergolet or your dealer. Several solutions to this problem. |
| Fault: Does not charge | Possible cause: Charger not connected to main supply. Solution: Connect charger. Possible cause: Defect charger Faultfinding: If another charger is available try this Solution: Request new charger Possible cause: Connection from hand control to charger defect Faultfinding: If another charger is available try this Solution: Request new hand control |

6. Technical data and sketches

Measurements ceiling mounted

- A:** 320 mm
- B:** 580 mm (standard measurements)
see also accessories
- C:** 170 mm
- D:** 430 mm
- E:** 1950 mm

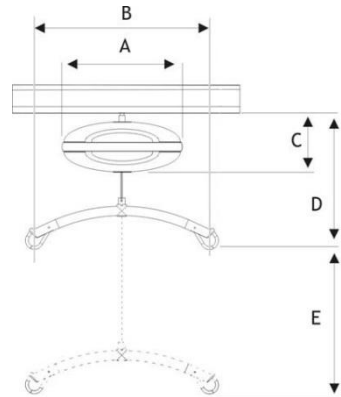

Measurements strap mounted

- A:** 320 mm
- B:** 580 mm (standard measurements)
see also accessories
- C:** 155 mm
- D:** 465 mm
- E:** 1950 mm

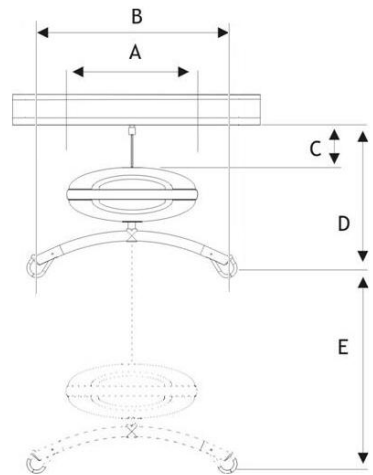

6.1 Luna – Technical specifications

- Max. capacity: 200 or 275 kg
- Length of lifting strap: 2200 mm
- Weight: 6.7 kg w/o spreader bar
- Measurements: 320 x 130 mm
- Battery operation: 36 V lead acid batteries
- Charging: 100 - 240 V, 0,5A.
- Chassis: Aluminium
- Housing: High impact, moulded ABS
- Noise: Lwa during lifting/lowering without load is 49 dB(A)
Lwa during lifting/lowering at maximum load is 53 dB(A)

- IP-class: Lifting unit: IP20
Charger: IPX4
Hand control: IPX4

More test results may be available by contacting Ergolet.

7. Environment and quality

Luna has an expected life time of minimum 10 years under the assumption that all recommended service checks have been carried out and that the normal maintenance and care instructions have been followed.

7.1 Batteries and environment

Disposal of this track lift can be made through Ergolet. After Luna's useful lifetime Ergolet will receive the unit back and split the individual fractions in an environmentally friendly way either through reuse or recycling. Fractions that contain halogens, aluminium, lead acid batteries, ABS plastic; steel may damage the environment if not handled in an environmentally responsible way.

Luna is equipped with 1 battery which may be returned either to the local recycling station or to Ergolet at the end of their lifetime.

8. Accessories and spare parts

Lifting unit: Luna

015-01910 through to 015-01920 200 kg

015-01936, 015-01937 275 kg



Hand control

015-01947



Standard spreader bar Luna / 200 kg

015-01970 58 cm

015-01971 Strap mounting 48 cm

015-01972 36 cm

015-01975 58 cm

015-01976 Bayonet mounting 48 cm

015-01977 36 cm



Spreader bar for tilt Luna / 200 kg

015-01980 58 cm

015-01981 Bayonet mounting 48 cm

015-01982 36 cm



Spreader bar with double hook for room to room transfer 200 kg

015-01984 w. double hook 48 cm



3-point spreader bar Luna / 200 kg

015-01990 Strap mounting

015-01991 Bayonet mounting



4-point spreader bar Luna / 200 kg

015-01985 Strap mounting

015-01986 Bayonet mounting



Standard spreader bar Luna / 275 kg

015-01968 Strap mounting

015-01974 Bayonet mounting



A complete list of spare parts for the Luna is available. Please contact Ergolet for details.

Manufacturer:

Ergolet

Taarnborgvej 12 C

4220 Korsoer

Denmark

Tlf: + 45 70 27 37 20

Fax: + 45 70 27 37 19

Email: ergolet@ergolet.dk

www.ergolet.com

93/42/EØF CLASS I

EN ISO 10535

EN 60601-1-2



910-00757UK